



 **SCAFFCO**
Formwork & Scaffolding

Perfect Aluminum Panel System (PAP)

Sustainable, Light Weight and High Strength Formwork

Decades of experience in the formwork and scaffolding industry is reflected in Perfect Aluminum Panel System. A special component made from a robust aluminum alloy provides the Perfect Aluminum Panel (PAP) with its high level of rigidity and versatility; combined with superior quality 15 mm thick formwork panel, birch plywood and plastic overlay. It can absorb concrete pressures up to 60 kN/m² without any problems. Its robust design makes it an ideal formwork for the modern construction industry.



STRATO-STOCK

Birch Plywood Panel with Plastic Overlay

Formwork Sheathing:

STRATO-STOCK is a birch plywood panel with plastic overlay. The plastic overlay based on polyolefins, allows an improvement of the traditional phenolic panel:

- Abrasion Resistance is considerably higher
- It does not splinter when the panel is nailed
- Faster cleaning
- Plywood life span guaranteed 200 times pouring.

Waterproof

The overlay waterproofs against chemical and weathering agents avoiding deformations and extending the panel life.

Easy cleaning

Smooth and waterproof surfaces allow the panel to be easily cleaned of material or colour residue.

Abrasion resistance

The product is developed to withstand wear caused by concrete.

Systematic Modular Design

Sound engineering design and optimisation of production processes make it widely used in a variety of architectural environments, e.g. concrete walls, slabs, columns, beams and other concrete pouring.

High Assembly Efficiency

With maximum panel height of 2400mm it becomes much easier to combine with no restrictions in the direction of any modules. Panel weight is as low as 26 kg/m². Ease in moving makes it possible for only a single person to operate.

Monolithic Pouring

Perfect Aluminum Panels (PAP) makes it easier for monolithic pouring, saving time and cost.

Good Construction Quality

The specially extruded surface is highly resistant of wear and corrosion, simple maintenance, easy mould release after pouring and has smooth wall surface. A special manufacturing process ensures the accuracy of the sizes, making the assembly better in smaller patchwork wall.

Perfect Accessory System

A full range of high-strength parts makes it easy for the form structures composition and removal much simpler during the workers training. A worker can even operate without special tools to complete the disassembly work.

Long Life and Easy maintenance

The life of the aluminum panel has been proven to withstand more than 200 pours and be easily cleaned after use. High residual value and higher hedge ratio with substantial reduction of project cost is the effective protection of any construction investment

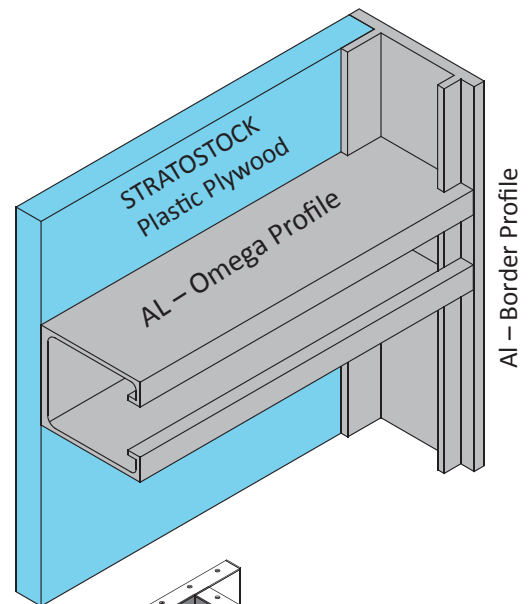

AL – Border Profile

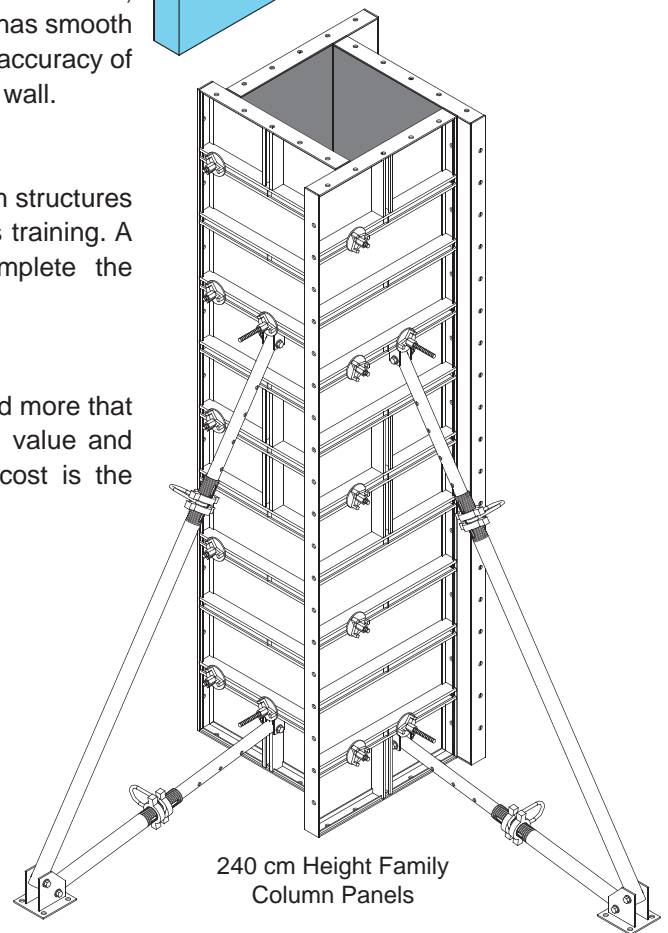

240 cm Height Family Column Panels

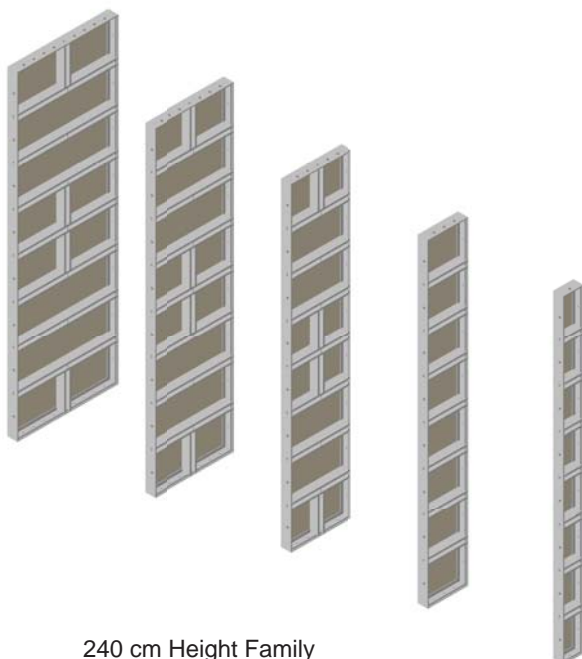
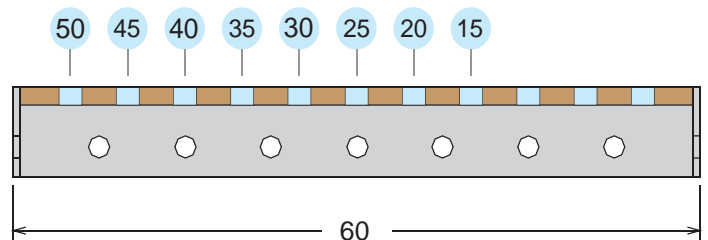

240 cm Height Family Wall Panels

Column & Wall Panel Sizes

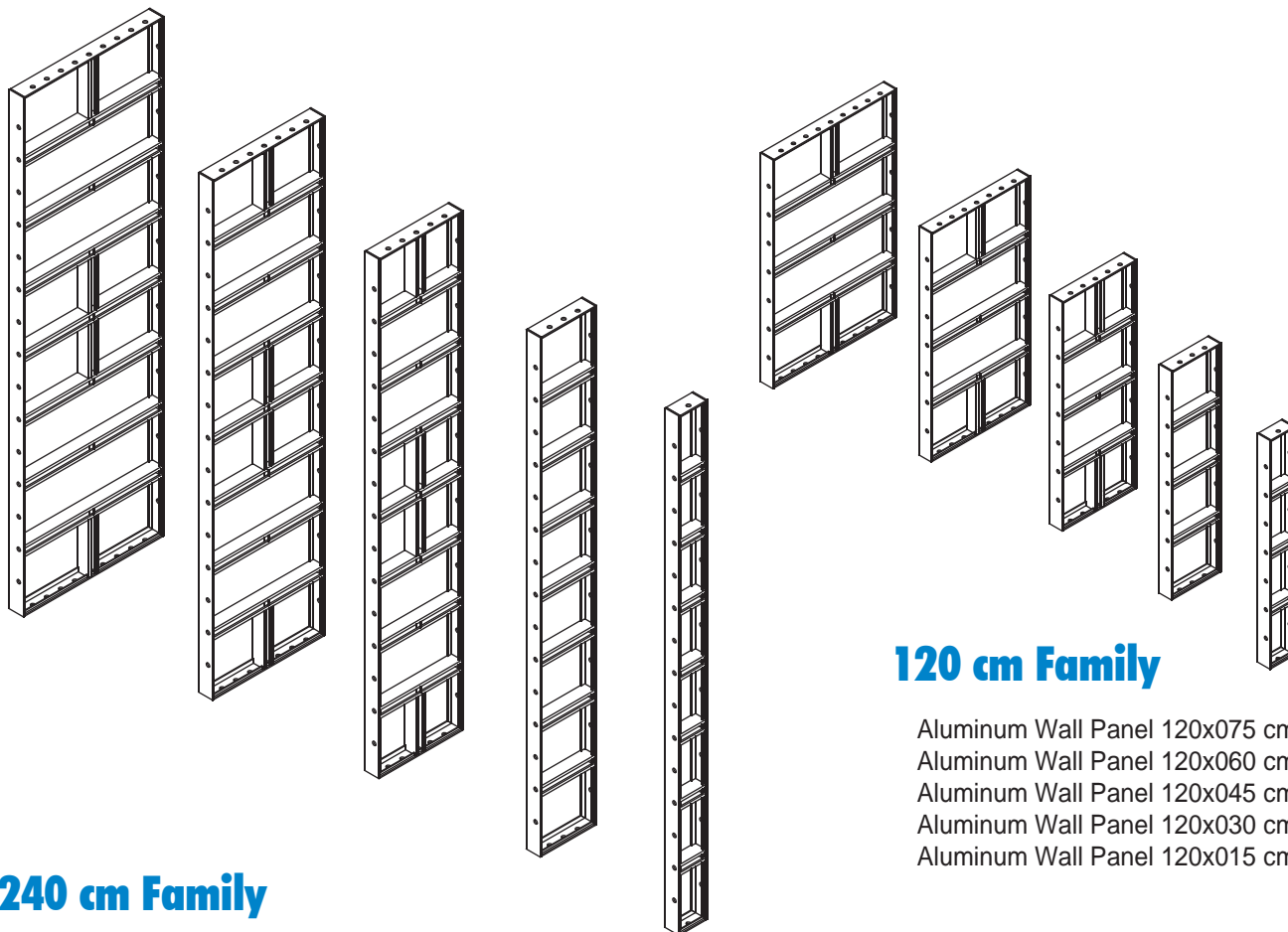

120 cm Family

- Aluminum Wall Panel 120x075 cm
- Aluminum Wall Panel 120x060 cm
- Aluminum Wall Panel 120x045 cm
- Aluminum Wall Panel 120x030 cm
- Aluminum Wall Panel 120x015 cm

240 cm Family

- Aluminum Wall Panel 240x075 cm
- Aluminum Wall Panel 240x060 cm
- Aluminum Wall Panel 240x045 cm
- Aluminum Wall Panel 240x030 cm
- Aluminum Wall Panel 240x015 cm

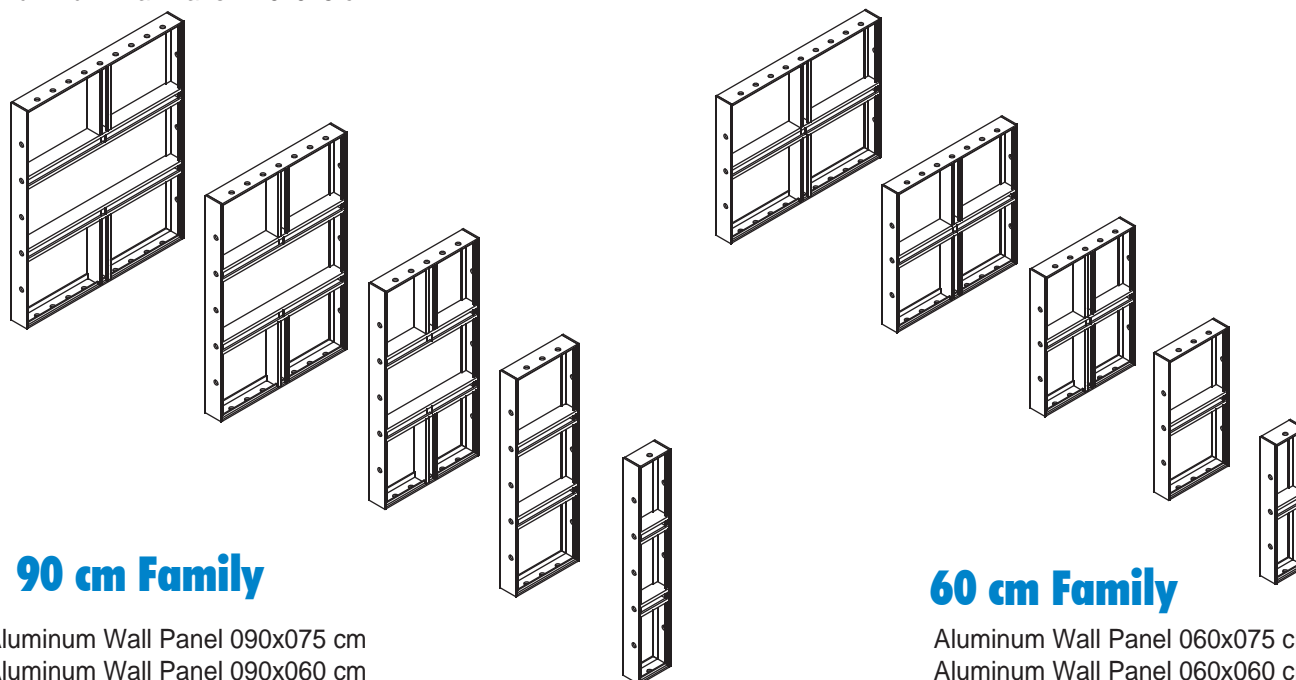

90 cm Family

- Aluminum Wall Panel 090x075 cm
- Aluminum Wall Panel 090x060 cm
- Aluminum Wall Panel 090x045 cm
- Aluminum Wall Panel 090x030 cm
- Aluminum Wall Panel 090x015 cm

60 cm Family

- Aluminum Wall Panel 060x075 cm
- Aluminum Wall Panel 060x060 cm
- Aluminum Wall Panel 060x045 cm
- Aluminum Wall Panel 060x030 cm
- Aluminum Wall Panel 060x015 cm

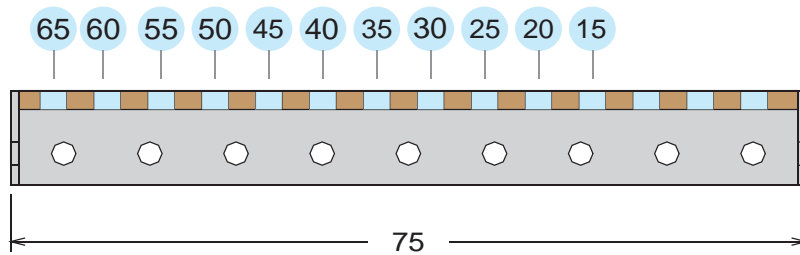
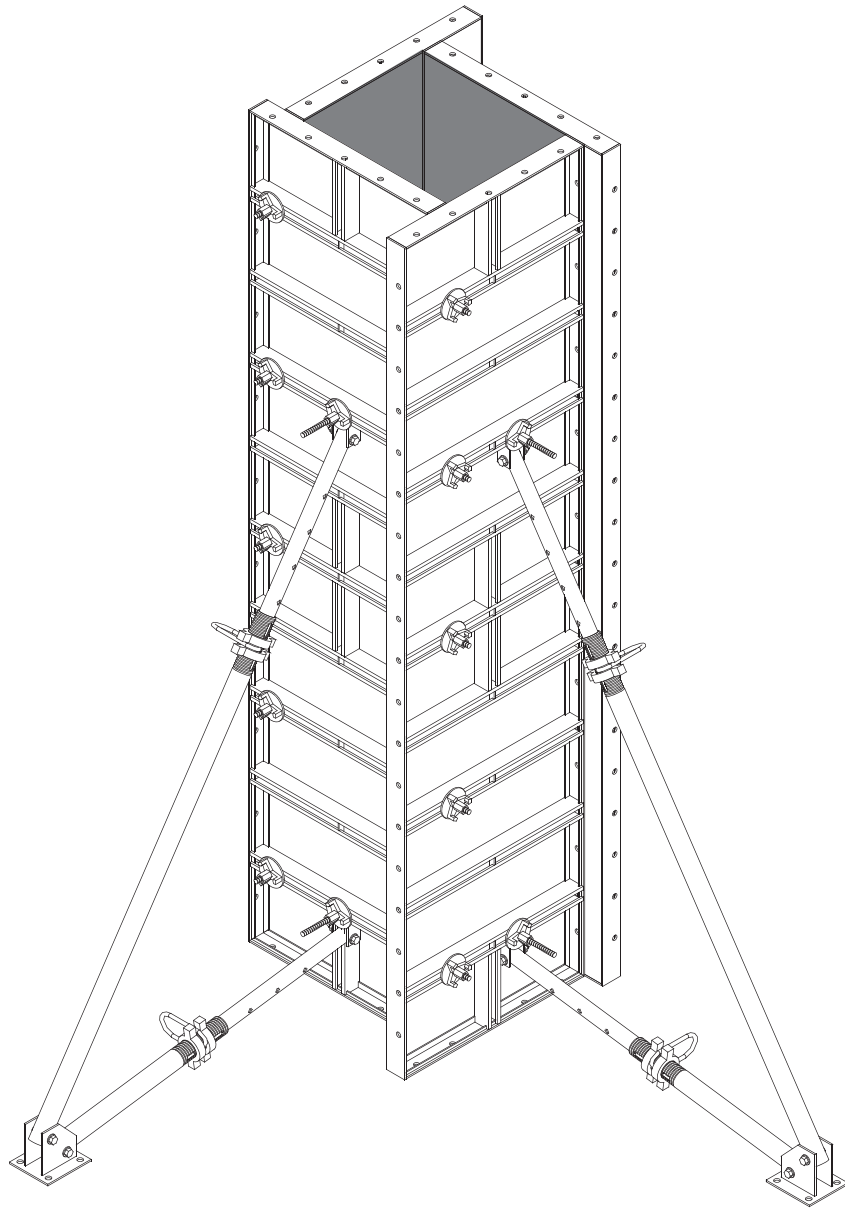



AL-Steel T-Head Connector



Plastic Plug



AL-Steel Wedge Pin



AL-Steel Access Bracket



AL-Steel Lifting Hook



AL-Steel Clamp 27

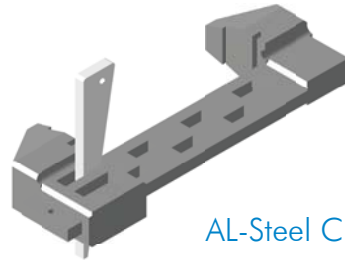



AL-Steel Panel Clamp



AL-Steel Prop Bracket



	Wt. (kg)	Code	
Aluminum Column Panel (ACP)			
	ACP 060x015 cm	3.40	ALCP060015
	ACP 060x030 cm	5.10	ALCP060030
	ACP 060x045 cm	7.70	ALCP060045
	ACP 060x060 cm	9.50	ALCP060060
	ACP 060x075 cm	11.10	ALCP060075
	ACP 090x015 cm	5.00	ALCP090015
	ACP 090x030 cm	7.60	ALCP090030
	ACP 090x045 cm	11.00	ALCP090045
	ACP 090x060 cm	13.50	ALCP090060
	ACP 090x075 cm	16.10	ALCP090075
	ACP 120x015 cm	6.60	ALCP120015
	ACP 120x030 cm	10.00	ALCP120030
	ACP 120x045 cm	14.20	ALCP120045
	ACP 120x060 cm	17.60	ALCP120060
	ACP 120x075 cm	21.00	ALCP120075
	ACP 240x015 cm	13.10	ALCP240015
	ACP 240x030 cm	19.70	ALCP240030
	ACP 240x045 cm	28.00	ALCP240045
	ACP 240x060 cm	34.70	ALCP240060
	ACP 240x075 cm	41.20	ALCP240075
	ACP 300x015 cm	16.40	ALCP300015

	Wt. (kg)	Code	
AL-Steel External Corner (AL-SEC)			
	AL-SEC 060 cm	4.23	XALMECP060
	AL-SEC 090 cm	6.27	XALMECP090
	AL-SEC 120 cm	8.31	XALMECP120
	AL-SEC 150 cm	10.36	XALMECP150
	AL-SEC 180 cm	12.40	XALMECP180
	AL-SEC 210 cm	14.51	XALMECP210
	AL-SEC 240 cm	16.63	XALMECP240
	AL-SEC 270 cm	18.67	XALMECP270
	AL-SEC 300 cm	20.78	XALMECP300

Finish: Painted + E/P

	Wt. (kg)	Code	
AL-Steel External Corner Connector - Waler (AL-SECC)			
	AL-SECC (Waler) 060 cm	4.65	XALMECCWP060
	AL-SECC (Waler) 090 cm	7.26	XALMECCWP090
	AL-SECC (Waler) 120 cm	9.86	XALMECCWP120
	AL-SECC (Waler) 240 cm	20.38	XALMECCWP240
	AL-SECC (Waler) 270 cm	23.00	XALMECCWP270
	AL-SECC (Waler) 300 cm	25.60	XALMECCWP300

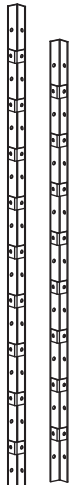
	Wt. (kg)	Code	
AL-Steel Internal Corner (AL-SIC)			
	AL-SIC 060 cm (W/2x Hex Bolt 75mm & Ring)	5.71	XALMIPC060
	AL-SIC 090 cm (W/2x Hex Bolt 75mm & Ring)	7.75	XALMIPC090
	AL-SIC 120 cm (W/2x Hex Bolt 75mm & Ring)	10.31	XALMIPC120
	AL-SIC 150 cm (W/2x Hex Bolt 75mm & Ring)	12.35	XALMIPC150
	AL-SIC 180 cm (W/2x Hex Bolt 75mm & Ring)	14.39	XALMIPC180
	AL-SIC 210 cm (W/2x Hex Bolt 75mm & Ring)	16.95	XALMIPC210
	AL-SIC 240 cm (W/2x Hex Bolt 75mm & Ring)	18.99	XALMIPC240
	AL-SIC 270 cm (W/2x Hex Bolt 75mm & Ring)	21.04	XALMIPC270
	AL-SIC 300 cm (W/2x Hex Bolt 75mm & Ring)	23.08	XALMIPC300

Finish: Painted + E/P

	Wt. (kg)	Code	
AL-Steel Jacky (AL-SJ)			
	AL-SJ 060 cm (W/2xCarrage Bolt)	2.10	XALMJP060
	AL-SJ 090 cm (W/3xCarrage Bolt)	3.13	XALMJP090
	AL-SJ 120 cm (W/3xCarrage Bolt)	4.08	XALMJP120
	AL-SJ 150 cm (W/3xCarrage Bolt)	5.04	XALMJP150
	AL-SJ 180 cm (W/4xCarrage Bolt)	6.07	XALMJP180
	AL-SJ 210 cm (W/5xCarrage Bolt)	7.11	XALMJP210
	AL-SJ 240 cm (W/5xCarrage Bolt)	8.06	XALMJP240
	AL-SJ 270 cm (W/5xCarrage Bolt)	9.01	XALMJP270
	AL-SJ 300 cm (W/6xCarrage Bolt)	10.05	XALMJP300

Finish: Painted + E/P

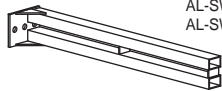
	Wt. (kg)	Code	
AL-Steel Waler Grider (AL-SWG)			
	AL-SWG 075 cm	7.98	XALMWGP075
	AL-SWG 090 cm	9.31	XALMWGP090

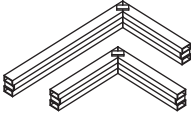
	Wt. (kg)	Code	
AL-Steel Corner Waler (AL-SCW)			
	AL-SCW 030 cm	3.89	XALMCWP030
	AL-SCW 045 cm	5.69	XALMCWP045
	AL-SCW 060 cm	7.49	XALMCWP060

Finish: Painted + E/P

	Wt. (kg)	Code	
AL-Steel Adj Corner Waler 050 cm			
	AL-Steel Adj Corner Waler 050 cm - Painted	6.49	XALMACWP050

Finish: Painted + E/P

	Wt. (kg)	Code	
Round Wing Nut			
	Round Wing Nut (Anchor Nut)	0.63	XANUT15100

Finish: Electroplated
DIA.: 100 mm

	Wt. (kg)	Code	
AL-Steel Clamp 27			
	AL-Steel Clamp 27	2.50	XALMCL027

Finish: Painted + E/P

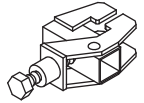
	Wt. (kg)	Code	
AL-Steel Panel Clamp			
	AL-Steel Panel Clamp (P)	0.95	XALMCP001
	AL-Steel Panel Clamp (E/P)	0.95	XALMCE001

Finish: Painted + E/P

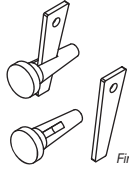
	Wt. (kg)	Code	
AL-Steel Wedge Pin			
	AL-Steel Wedge Pin	0.01	XALMWP01

Finish: Painted + E/P

	Wt. (kg)	Code	
AL-Steel Prop Bracket			
	AL-Steel Prop Bracket (With M16x100)	0.74	XALMPBP001

Finish: Painted + E/P

	Wt. (kg)	Code
AL-Steel Waler (AL-SW)		
		
AL-SW 030.0 cm	1.92	XALMWP030
AL-SW 037.5 cm	2.37	XALMWP037
AL-SW 045.0 cm	2.82	XALMWP045
AL-SW 052.5 cm	3.27	XALMWP052
AL-SW 060.0 cm	3.72	XALMWP060
AL-SW 067.5 cm	4.23	XALMWP067
AL-SW 075.0 cm	4.68	XALMWP075
AL-SW 082.5 cm	5.13	XALMWP082
AL-SW 090.0 cm	5.58	XALMWP090
AL-SW 097.5 cm	6.03	XALMWP097
AL-SW 105.0 cm	6.48	XALMWP105
AL-SW 120.0 cm	6.93	XALMWP112
AL-SW 127.5 cm	7.38	XALMWP120
AL-SW 135.0 cm	7.83	XALMWP127
AL-SW 142.5 cm	8.34	XALMWP135
AL-SW 150.0 cm	8.79	XALMWP142
AL-SW 157.5 cm	9.24	XALMWP150
AL-SW 165.0 cm	9.69	XALMWP157
AL-SW 172.5 cm	10.14	XALMWP165
AL-SW 180.0 cm	10.59	XALMWP172
AL-SW 187.5 cm	11.04	XALMWP180
AL-SW 195.0 cm	11.54	XALMWP187
AL-SW 202.5 cm	11.99	XALMWP195
AL-SW 210.0 cm	12.44	XALMWP202
AL-SW 217.5 cm	12.89	XALMWP210
AL-SW 225.0 cm	13.34	XALMWP217
AL-SW 232.5 cm	13.79	XALMWP225
AL-SW 240.0 cm	14.24	XALMWP232
AL-SW 247.5 cm	14.69	XALMWP240
AL-SW 255.0 cm	15.20	XALMWP247
AL-SW 262.5 cm	15.65	XALMWP255
AL-SW 270.0 cm	16.10	XALMWP262
AL-SW 277.5 cm	16.55	XALMWP270
AL-SW 285.0 cm	17.00	XALMWP277
AL-SW 292.5 cm	17.45	XALMWP285
AL-SW 300.0 cm	17.90	XALMWP292
AL-SW 307.5 cm	18.35	XALMWP300
AL-SW 315.0 cm	18.86	XALMWP307
AL-SW 322.5 cm	19.31	XALMWP315
AL-SW 330.0 cm	19.76	XALMWP322
AL-SW 337.5 cm	20.21	XALMWP330
AL-SW 345.0 cm	20.66	XALMWP337
AL-SW 352.5 cm	21.11	XALMWP345
AL-SW 360.0 cm	21.56	XALMWP352
	22.01	XALMWP360

Finish: Painted + E/P
Section: 60x40x2MM

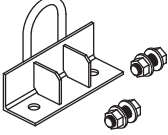
	Wt. (kg)	Code
AL-Steel Lifting Hook		
		
AL-Steel Lifting Hook 22.5 cm (W/2xM16x40 Bolt & Nut)	2.28	XALMLHP225

Finish: Painted + E/P

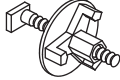
	Wt. (kg)	Code
AL-Steel Panel Connector (AL-SPC)		
		
AL-SPC 015 cm (With Anchor nut)	0.97	XALMPCP015
AL-SPC 020 cm (With Anchor nut)	1.04	XALMPCP020
AL-SPC 025 cm (With Anchor nut)	1.12	XALMPCP025

Finish: Painted + E/P

	Wt. (kg)	Code
AL-Steel T-Head Connector (AL-STHC)		
		
AL-STHC 015 cm (With Anchor nut)	0.92	XALMTHCP015
AL-STHC 020 cm (With Anchor nut)	1.00	XALMTHCP020
AL-STHC 025 cm (With Anchor nut)	1.08	XALMTHCP025

Finish: Painted + E/P

	Wt. (kg)	Code
AL - Plastic Plug		
		
AL - Plastic Plug	0.002	XALMPP01

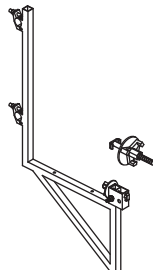
	Wt. (kg)	Code
AL-Steel Access Bracket (With T-Head Connector)		
		
AL-Steel Access Bracket (W/T - Head Connector 20 cm)	9.48	XALMABTHC01

Finish: Painted + E/P

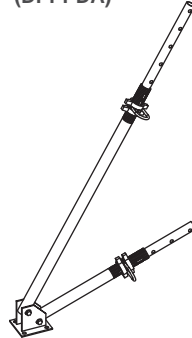
	Wt. (kg)	Code
Double Push Pull Props Double Adjustable (DPPDA)		
		
DPPDA 150cm (E/P Collar) HD	20.00	FDPD10015030E
DPPDA 250cm (E/P Collar) HD	22.24	FDPD15025030E
DPPDA 300cm (E/P Collar) HD	24.36	FDPD17030030E
DPPDA 350cm (E/P Collar) HD	26.02	FDPD20035030E
DPPDA 400cm (E/P Collar) HD	27.26	FDPD25040030E
DPPDA 450cm (E/P Collar) HD	31.93	FDPD25045030E
DPPDA 500cm (E/P Collar) HD	33.61	FDPD30050030E
DPPDA 550cm (E/P Collar) HD	35.28	FDPD35055030E
DPPDA 600cm (E/P Collar) HD	36.96	FDPD40060030E

	Wt. (kg)	Code
Single Rocking Push-Pull Prop (SRPPP)		
		
SRPPP 150cm (Painted Collar) HD	10.09	FRPP10015030P
SRPPP 200cm (Painted Collar) HD	12.21	FRPP12020030P
SRPPP 250cm (Painted Collar) HD	13.84	FRPP15025030P
SRPPP 300cm (Painted Collar) HD	15.96	FRPP17030030P
SRPPP 350cm (Painted Collar) HD	17.62	FRPP20035030P
SRPPP 400cm (Painted Collar) HD	19.30	FRPP25040030P
SRPPP 450cm (Painted Collar) HD	21.42	FRPP25045030P
SRPPP 500cm (Painted Collar) HD	23.09	FRPP30050030P
SRPPP 550cm (Painted Collar) HD	24.77	FRPP35055030P
SRPPP 600cm (Painted Collar) HD	26.44	FRPP40060030P
SRPPP 150cm (E/P Collar) HD	10.09	FRPP10015030E
SRPPP 200cm (E/P Collar) HD	12.21	FRPP12020030E
SRPPP 250cm (E/P Collar) HD	13.84	FRPP15025030E
SRPPP 300cm (E/P Collar) HD	15.96	FRPP17030030E
SRPPP 350cm (E/P Collar) HD	17.62	FRPP20035030E
SRPPP 400cm (E/P Collar) HD	19.30	FRPP25040030E
SRPPP 450cm (E/P Collar) HD	21.42	FRPP25045030E
SRPPP 500cm (E/P Collar) HD	23.09	FRPP30050030E
SRPPP 550cm (E/P Collar) HD	24.77	FRPP35055030E
SRPPP 600cm (E/P Collar) HD	26.44	FRPP40060030E

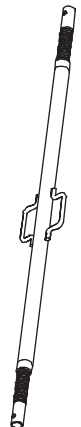
	Wt. (kg)	Code
Single Stabilizer (SS)		
		
SS 48-150 cm Painted	8.83	FSZS3848P150
SS 48-200 cm Painted	10.71	FSZS3848P200
SS 48-250 cm Painted	12.63	FSZS3848P250
SS 48-300 cm Painted	14.72	FSZS3848P300
SS 48-350 cm Painted	16.80	FSZS3848P350
SS 48-400 cm Painted	19.74	FSZS3848P400
SS 48-150 cm E/P	8.83	FSZS3848E150
SS 48-200 cm E/P	10.71	FSZS3848E200
SS 48-250 cm E/P	12.63	FSZS3848E250
SS 48-300 cm E/P	14.72	FSZS3848E300
SS 48-350 cm E/P	16.80	FSZS3848E350
SS 48-400 cm E/P	19.74	FSZS3848E400
SS 60-150 cm Painted	10.70	FSZS3860P150
SS 60-200 cm Painted	13.08	FSZS3860P200
SS 60-250 cm Painted	15.55	FSZS3860P250
SS 60-300 cm Painted	18.19	FSZS3860P300
SS 60-350 cm Painted	20.84	FSZS3860P350
SS 60-400 cm Painted	24.34	FSZS3860P400
SS 60-450 cm Painted	26.99	FSZS3860P450
SS 60-500 cm Painted	29.64	FSZS3860P500
SS 60-550 cm Painted	32.28	FSZS3860P550
SS 60-600 cm Painted	34.93	FSZS3860P600
SS 60-700 cm Painted	40.22	FSZS3860P700
SS 60-150 cm E/P	10.70	FSZS3860E150
SS 60-200 cm E/P	13.08	FSZS3860E200
SS 60-250 cm E/P	15.55	FSZS3860E250
SS 60-300 cm E/P	18.19	FSZS3860E300
SS 60-350 cm E/P	20.84	FSZS3860E350
SS 60-400 cm E/P	24.34	FSZS3860E400
SS 60-450 cm E/P	26.99	FSZS3860E450
SS 60-500 cm E/P	29.64	FSZS3860E500
SS 60-550 cm E/P	32.28	FSZS3860E550
SS 60-600 cm E/P	34.93	FSZS3860E600
SS 60-700 cm E/P	40.22	FSZS3860E700

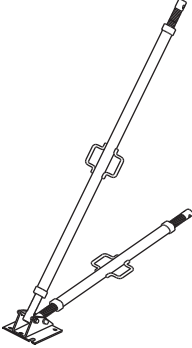
	Wt. (kg)	Code
Double Stabilizers (DS)		
		
DS 48-250 cm Painted	24.47	FSZD3848P250
DS 48-300 cm Painted	28.43	FSZD3848P300
DS 48-350 cm Painted	30.51	FSZD3848P350
DS 48-400 cm Painted	35.37	FSZD3848P400
DS 48-250 cm E/P	24.47	FSZD3848E250
DS 48-300 cm E/P	28.43	FSZD3848E300
DS 48-350 cm E/P	30.51	FSZD3848E350
DS 48-400 cm E/P	35.37	FSZD3848E400
DS 60-250 cm Painted	29.25	FSZD3860P250
DS 60-300 cm Painted	34.28	FSZD3860P300
DS 60-350 cm Painted	36.92	FSZD3860P350
DS 60-400 cm Painted	40.42	FSZD3860P400
DS 60-450 cm Painted	45.53	FSZD3860P450
DS 60-500 cm Painted	48.18	FSZD3860P500
DS 60-550 cm Painted	50.83	FSZD3860P550
DS 60-250 cm E/P	29.25	FSZD3860E250
DS 60-300 cm E/P	34.28	FSZD3860E300
DS 60-350 cm E/P	36.92	FSZD3860E350
DS 60-400 cm E/P	40.42	FSZD3860E400
DS 60-450 cm E/P	45.53	FSZD3860E450
DS 60-500 cm E/P	48.18	FSZD3860E500
DS 60-550 cm E/P	50.83	FSZD3860E550

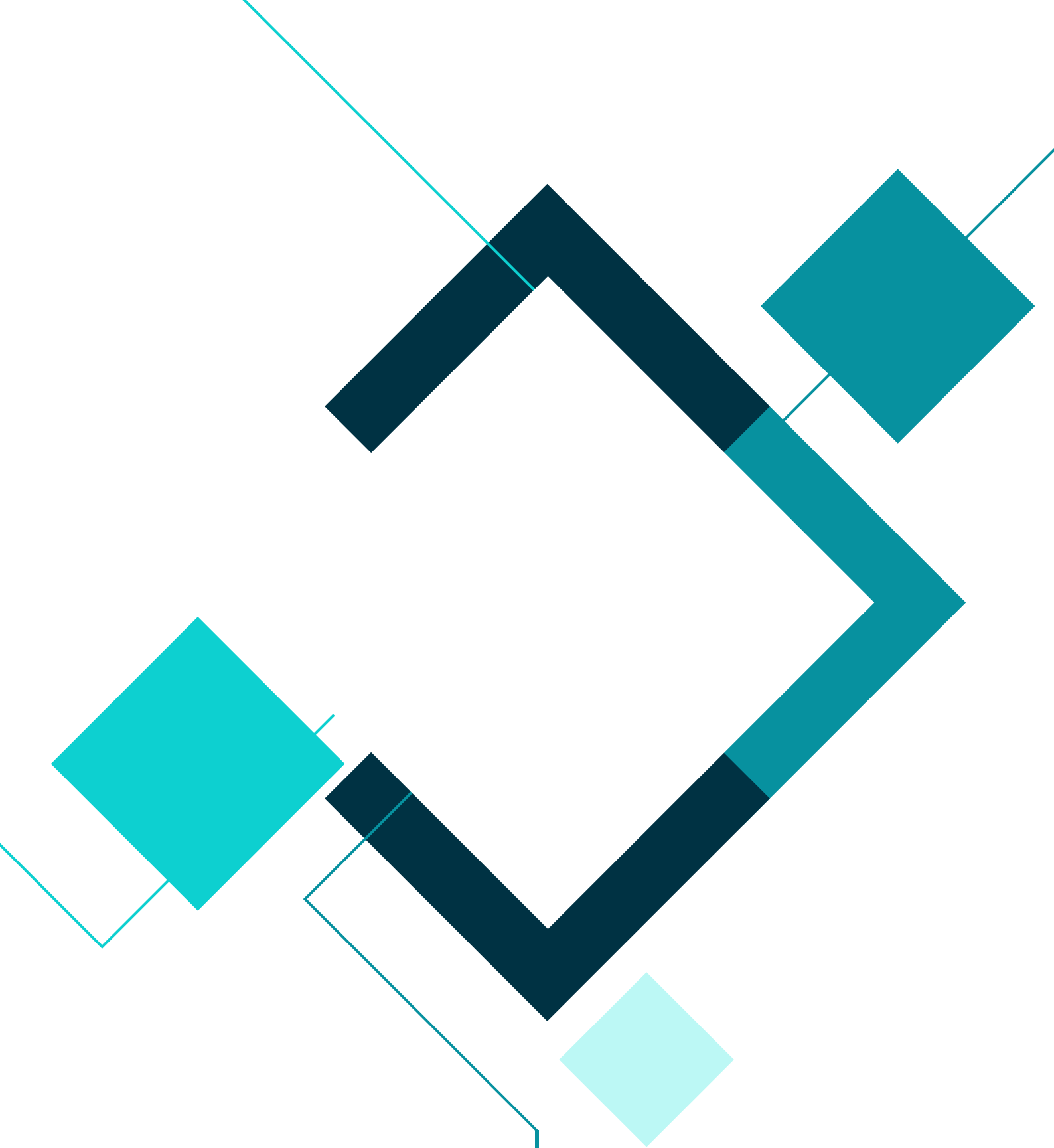

Abu Dhabi

Dubai

T: +971 2 5500688

T: +971 4 8862855

F: +971 2 5500689

F: +971 4 5562558

P.O. BOX: 41851, Abu Dhabi, UAE

P.O. BOX: 18234, Jebel Ali, UAE

WWW.SCAFFCO.COM